



HYGREE



*EXPERIENCE*  
*the* **UNSEEN**  
**BEAUTY**





**Rajesh M Bathija**  
Founder & CEO

## *My Expression to it*

*A feeling is only an experience that is one's personal emotion.*

*To feel this one needs to indulge.*

*To me bathtubs are the epitome of luxury.*

### **IT IS MY CHOICE!!!**

I meditate in the bathtub. The water needs to be very hot, so hot you can barely stand putting your foot in it. Then you lower yourself, inch by inch, till the water's up to your neck.

I feel so much of myself when I'm in a hot bath."

I remember the tubs, too: exciting, comfortable, enveloping, and exhilarating. The modern shaped tubs and the fancy features, and I remember the shapes and sizes of the water taps and the different sorts of spouts.

The dream bathtub is pushed into the room open and the dappled depths of our imagination become a uniformed intruder, often out of scale with its surroundings and nearly always discordant in colour and texture. My tubs overlooking indoor lily ponds, gives me sense of oneness with nature

I can say I have experienced bliss "An over-indulgence of anything, even something as pure as water, can intoxicate."

I have had my moments with me and myself "They both listened silently to the water, which to them was not just water, but the voice of life, the voice of Being, the voice of perpetual Becoming."

### **MY BATHTUB SPEAKS TO ME**

"Even the memory of cradling her in my arms is pure euphoria. And all that I ask out of life is that it be constant and unending euphoria."

**Roman Payne**

In one drop of water are found all the secrets of all the oceans; in one aspect of **You** are found all the aspects of existence

It's time to find your one... at **HYGREE** you can be sure to find one for your moods, find your essence, make it yours, your experience can unleash your hidden desires,

You will soon find your first line and pen your book Or you may find the tune to make the song of your life....

It's only this one Life that has to be experienced with the **HYGREE** wellness.

At **HYGREE** we care for your feelings and this the testimonial for us to say in times to come.



HYGREE  
www.hygree.in

# CONTENTS

DO YOU KNOW

06

SINGLE BATHTUB

08

TWIN BATHTUB

16

CORNER BATHTUB

22

ELDER BATHTUB

26

ROUND BATHTUB

28

FREESTANDING  
BATHTUB

34

STEAM ROOM  
WALK IN

36

SAUNA ROOM  
WALK IN

44

STEAM ROOM  
WITH BATHTUB

46

# Water *quite aptly called the* **“Elixir of life”**

People have always been naturally drawn to water as a source of comfort - The soothing sounds of a bubbling brook, the relaxing steam of a natural hot spring. Water therapy in a Whirlpool Hot Tub combines all the best calming features of water - opening the blood vessels to improve circulation, relaxing the muscles and providing an escape from the pressures of daily life.



HYGREE  
www.hygree.in

# DID YOU KNOW

Warm water or “HYDRO ” therapy can promote relaxation, pain relief & much more....

## RELAXATION

DE Stress and soothen your senses-Unwind and Immerse.

## IMPROVED SLEEP HABITS

The National Institutes of Health estimates that 30 percent of Humans suffer from sleep disruption. All the benefits of immersing yourself in warm water-tension relief, improved circulation and more-also help create healthy sleep habits, according to the Better Sleep Council

## SOOTHENS THE OVER WORKED MUSCLES

Reduces muscle tension and overall discomfort resulting from stress.

## IMPROVES CIRCULATION

It reduces pain levels in those with arthritis by opening the blood vessels and increasing range of movement

## WARMS THE MUSCLES & JOINTS

And for those who suffer from lower-back pain, a 2012 article in the Journal of Musculoskeletal Research found that hydrotherapy provides more potential benefits when compared to land-based exercises.

## LOWER DIABETIC SUGAR LEVELS

A study by the New England Journal of Medicine found that bathing in a hot tub simulates the beneficial effects of exercise. The result is that patients with type 2 diabetes who soak in a hot tub for 30 minutes a day, 6 days a week for 3 weeks, experience a reduction in blood sugar levels by an average of 13%.

## LOWERS BLOOD PRESSURE

A recent study for the Mayo Clinic recommended that relaxing in a hot tub can be beneficial for heart disease patients. The study showed that relaxing in a hot tub is less stressful on the heart and more beneficial than working out on an exercise bike! The study also demonstrated that soaking in the hot tub for as little as 15 minutes will lower blood pressure

## RELEASES ENDORPHINS

Buoyancy eases pressure in joints and muscles, while heat increases blood flow to muscles and accelerates healing. Additionally, Hot tub jets provide therapeutic massage, stimulating the release of endorphins, which are the body's natural painkiller.

## .....DISCONNECT & EMERGE RENEWED

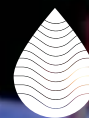

HYGREE  
www.hygree.in



### **Air-Jet**

The Air-Jet outlets at the bottom of the bath tub eject air. Full body Air-Jet massage creates the holistic relaxation.

---



### **Whirlpool**

The Jet inside the bathtub ejecting water creates a whirlpool effect. The whirlpool effects massages the lower body and legs giving total comfort.

---



### **Air-Jet + Whirlpool**

The luxury combination of Air-Jet and Whirlpool maximizes your bathroom experience.

---

Give yourself the time to indulge in luxury everyday. Taking a bath is no longer just about cleansing your body but also soaking in extreme comfort and tranquility.

**Hygree** wide-range of bathtubs are specially designed to maximise the little time you have for yourself. Unwind in a luxurious sanctuary for relaxation and meditation.



**HJT-121**

MODEL: HAVASU

SIZE: 1900X900X650MM

**Description:** Acrylic whirlpool bath tub

**Features & options**

1. Water jets- hydraulic massage
2. Waterfal- cascade side panel
3. Chromatherapy-light
4. Hand shower with multi flow
5. Hot & cold mixer
6. Spout- waterfall
7. Drainer
8. Over flow
9. Pump for whirlpool
10. Touch control panel
11. Automatic water lines cleaning system
13. Stainless steel frame
14. Three sides panel

**More options:**

1. Ozonizer- sterilization system
2. Temperature control heater
3. Music / radio player
4. Available version- only one

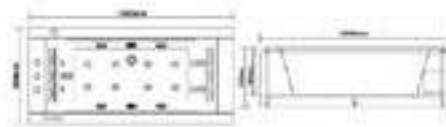

Chromatherapy LED Light water jet

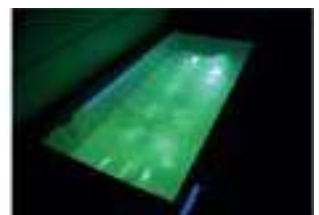

*Cascade Flow technology creates a shower experience similar to standing under a waterfall. A curved slit allows a wide stream of water to flow, warming and soothing the entire body for long-lasting relaxation.*





HYGREE  
www.hygree.in

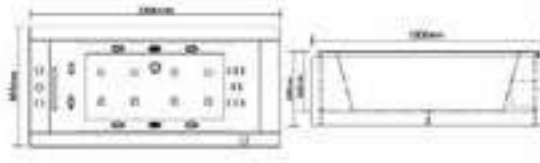

### HJT-130

MODEL: VICTORIA

Size: 1750X850X650MM

**Description:** Acrylic whirlpool bath tub

#### Features & options

1. Water jets- hydraulic massage
2. Waterfal- cascade side panel
3. Chromatherapy-light
4. Hand shower with multi flow
5. Hot & cold mixer
6. Spout- waterfall
7. Drainer

8. Over flow
9. Pump for whirlpool
10. Touch control panel
11. Automatic water lines cleaning system
13. Stainless steel frame
14. Three sides panel



#### More options:

1. Ozonizer- sterilization system
2. Temperature control heater
3. Music / radio player
4. Available version- only one

• **NEW LAUNCH**



HYGREE  
www.hygree.in

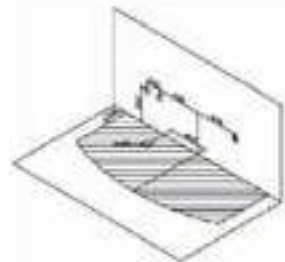
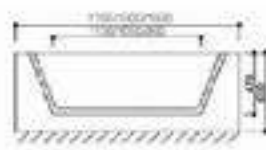
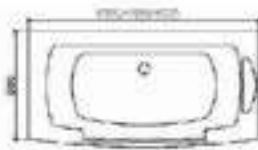

### HJT-118

MODEL: DETIAN

Size: 1700X800X600MM

**Description:** Acrylic whirlpool bath tub

#### Features & options

1. Water jets- hydraulic massage
2. Chromatherapy-light
3. Hand shower with multi flow
4. Hot & cold mixer
5. Spout- waterfal
6. Drainer
7. Over flow
8. Pump for whirlpool
9. Stainless steel frame
10. Tempered glass front panel

#### More options:

1. Touch control panel
2. Ozonizer- sterilization system
3. Temperature control heater
4. Air massage function
5. Music / radio player
6. Water lines cleaning system
7. Available version- left or right



HYGREE  
www.hygree.in



**HJT-102- MODEL:** IGUASU

**Size:** 1750X850X700MM

**HJT-102S-Size:** 1600X850X660MM

**Description:** Acrylic whirlpool bath tub

**Features & options**

1. Water jets- hydraulic massage
2. Chromatherapy-light
3. Hand shower with multi flow
4. Hot & cold mixer
5. Spout- deluxe
6. Drainer
7. Over flow
8. Pump for whirlpool
9. Stainless steel frame

**More options:**

1. Touch control panel
2. Ozonizer- sterilization system
3. Temperature control heater
4. Air massage function
5. Music / radio player
6. Water lines cleaning system
7. Available version- left or right

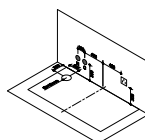
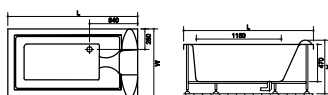

**HJT-103- MODEL:** MC WAY

**Size:** 1700X810X610MM

**HJT-104- Size:** 1500X810X610MM

**Description:** Acrylic whirlpool bath tub

**Features & options**

1. Water jets- hydraulic massage
2. Chromatherapy-light
3. Hand shower with multi flow
4. Hot & cold mixer
5. Spout- deluxe
6. Drainer
7. Over flow
8. Pump for whirlpool
9. Stainless steel frame

**More options:**

1. Touch control panel
2. Ozonizer- sterilization system
3. Temperature control heater
4. Air massage function
5. Music / radio player
6. Water lines cleaning system
7. Available version- left or right

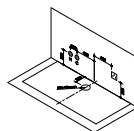
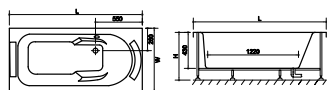



HYGREE  
www.hygree.in

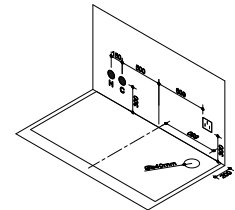
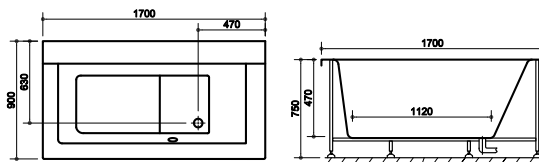

## HJT-114

MODEL: CUQUENAN

Size: 1700X900X750MM

**Description:** Acrylic whirlpool bath tub

### Features & options

1. Water jets- hydraulic massage
2. Chromatherapy-light
3. Hand shower with multi flow
4. Hot & cold mixer
5. Spout- waterfall cascade flow
6. Drainer
7. Over flow
8. Pump for whirlpool
9. Stainless steel frame

### More options:

1. Touch control panel
2. Ozonizer- sterilization system
3. Temperature control heater
4. Air massage function
5. Music / radio player
6. Water lines cleaning system
7. Available version- left or right



HYGREE  
www.hygree.in

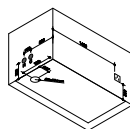
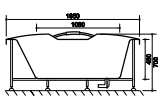
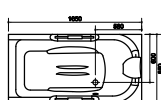

### HJT-101

MODEL: NIAGRA

Size: 1650X850X700MM

**Description:** Acrylic whirlpool bath tub

#### Features & options

1. Water jets- hydraulic massage
2. Chromatherapy-light
3. Hand shower with multi flow
4. Hot & cold mixer
5. Spout- deluxe
6. Drainer
7. Over flow
8. Pump for whirlpool
9. Stainless steel frame

#### More options:

1. Touch control panel
2. Ozonizer- sterilization system
3. Temperature control heater
4. Air massage function
5. Music / radio player
6. Water lines cleaning system
7. Available version- left or right



### HJT-134

MODEL: STAUBBACH

Size: 1440X760X610MM

**Description:** Acrylic whirlpool bath tub

#### Features & options

1. Water jets- hydraulic massage
2. Chromatherapy-light
3. Hand shower with multi flow
4. Hot & cold mixer
5. Spout- waterfal
6. Drainer
7. Over flow
8. Pump for whirlpool
9. Stainless steel frame
10. Tempered glass front panel
11. Three sides panel

#### More options:

1. Touch control panel
2. Ozonizer- sterilization system
3. Temperature control heater
4. Air massage function
5. Music / radio player
6. Water lines cleaning system
7. Available version- only one

• **NEW LAUNCH**



HYGREE  
www.hygree.in

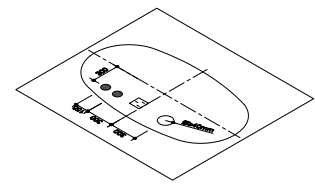
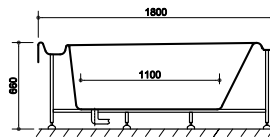
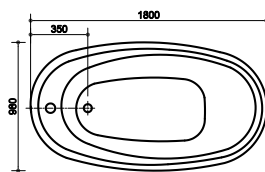

### HJT-115

MODEL: ANGEL

Size: 1800X980X660

Description: Acrylic whirlpool bath tub

#### Features & options

1. Water jets- hydraulic massage
2. Chromatherapy-light
3. Hand shower with multi flow
4. Hot & cold mixer
5. Spout- deluxe
6. Drainer
7. Over flow
8. Pump for whirlpool
9. Stainless steel frame
10. Free standing

#### More options:

1. Touch control panel
2. Ozonizer- sterlization system
3. Air massage function
4. Music / radio player
5. Water lines cleaning system
6. Available version- only one



HYGREE  
www.hygree.in

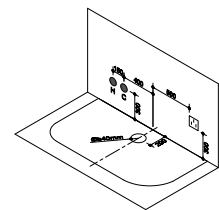
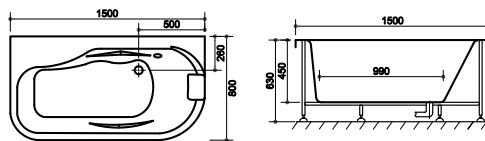

### HJT-137

MODEL: BAATARA

Size: 1500X800X630

**Description:** Acrylic Whirlpool Bath Tub

#### Features & options:

1. Water jets- hydraulic massage
2. Chromatherapy-light
3. Hand shower with multi flow
4. Hot & cold mixer
5. Spout- deluxe
6. Drainer
7. Over flow
8. Pump for whirlpool
9. Stainless steel frame
10. Three sides panel

#### More options:

1. Touch control panel
2. Ozonizer- sterilization system
3. Temperature control heater
4. Air massage function
5. Music / radio player
6. Water lines cleaning system
7. Available version- only one



HYGREE  
[www.hygree.in](http://www.hygree.in)

# TWIN COMPLEMENTING COUNTERPARTS

---

Combining Whirlpool Massage with Hot Water Bath also allows to unlock the benefits associated with the traditional Hot Springs.

Air baths utilize a blower that generates millions of tiny air bubbles through very small air jets in the bottom of the tub. These bubbles caress the body as they move toward the surface of the water and revitalize the bather with a light, full-body massage.





HYGREE  
www.hygree.in

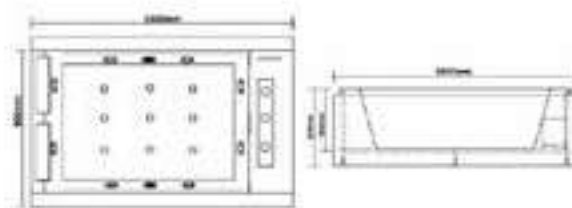

### HJT-129

MODEL: SUTHERLAND

Size: 1860X1220X700MM

**Description:** Acrylic whirlpool bath tub

#### Features & options

1. Water jets- hydraulic massage
2. Waterfal- cascade side panel
3. Chromatherapy-light
4. Hand shower with multi flow
5. Hot & cold mixer
6. Spout- waterfal
7. Drainer
8. Over flow

9. Pump for whirlpool
10. Touch control panel
11. Automatic water lines cleaning system
12. Stainless steel frame
13. Three sides panel



#### More options:

1. Ozonizer- sterilization system
2. Temperature control heater
3. Music / radio player
4. Available version- only one

• **NEW LAUNCH**



HYGREE  
www.hygree.in

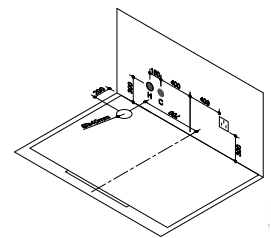
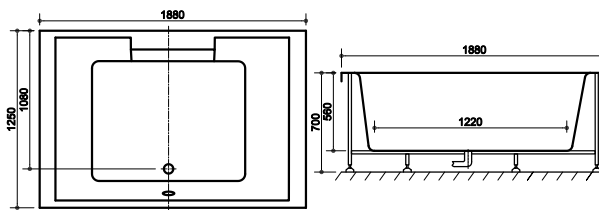

### HJT-113

MODEL: TUGELA

Size: 1880X1250X700MM

**Description:** Acrylic whirlpool bath tub

#### Features & options

1. Water jets- hydraulic massage
2. Chromatherapy-light
3. Hand shower with multi flow
4. Hot & cold mixer
5. Spout- deluxe
6. Drainer

7. Over flow
8. Pump for whirlpool
9. Stainless steel frame

#### More options:

1. Touch control panel
2. Ozonizer- sterilization system
3. Temperature control heater
4. Air massage function
5. Music / radio player
6. Water lines cleaning system
7. Available version- left or right



HYGREE  
www.hygree.in

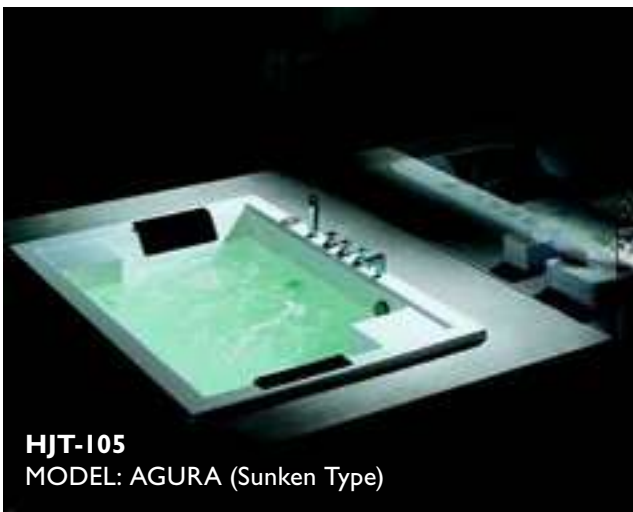
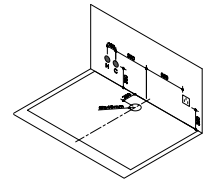
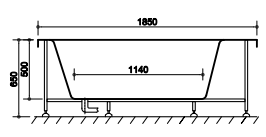
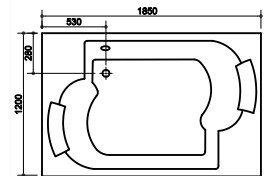

**HJT-105**  
MODEL: AGURA (Sunken Type)

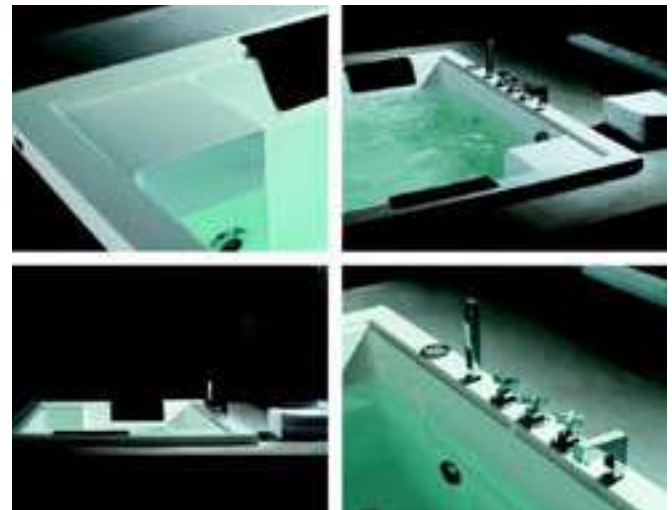

### HJT-150

MODEL: RHINE

Size: 1850X1200X650MM

**Description:** Acrylic whirlpool bath tub

#### Features & options

1. Water jets- hydraulic massage
2. Chromatherapy-light
3. Hand shower with multi flow
4. Hot & cold mixer
5. Spout- deluxe
6. Drainer

7. Over flow
8. Pump for whirlpool
9. Stainless steel frame

#### More options:

1. Touch control panel
2. Ozonizer- sterilization system
3. Temperature control heater
4. Air massage function
5. Music / radio player
6. Water lines cleaning system
7. Available version- left or right



HYGREE  
www.hygree.in





HYGREE  
www.hygree.in

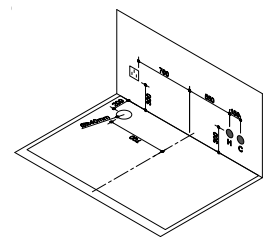
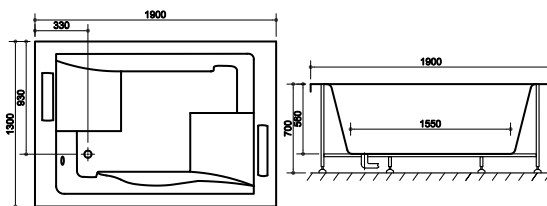

## HJT-151

MODEL: BROWNE

Size: 1900X1300X700MM

**Description:** Acrylic whirlpool bath tub

### Features & options

1. Water jets- hydraulic massage
2. Chromatherapy-light
3. Hand shower with multi flow
4. Hot & cold mixer
5. Spout- deluxe
6. Drainer

7. Over flow
8. Pump for whirlpool
9. Stainless steel frame

### More options:

1. Touch control panel
2. Ozonizer- sterilization system
3. Temperature control heater
4. Air massage function
5. Music / radio player
6. Water lines cleaning system
7. Available version- left or right



HYGREE  
www.hygree.in



# CORNER

---

## *Classic Curvatures*

Corner baths have a way of transforming your home to a very own spa-like retreat. Maximise Your Floor Space Using Less Wall Space.





HYGREE  
www.hygree.in

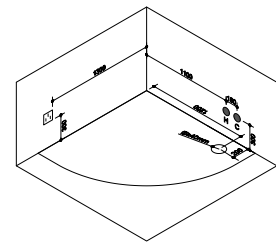
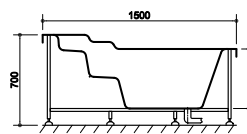
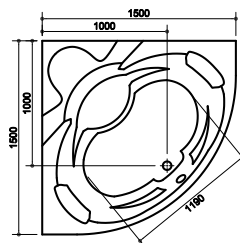

## HJT-110

MODEL: BIGAR

Size: 1500X1500X700MM

**Description:** Acrylic whirlpool bath tub

### Features & options

1. Water jets- hydraulic massage
2. Chromatherapy-light
3. Hand shower with multi flow
4. Hot & cold mixer
5. Spout-Waterfal
6. Drainer
7. Over flow
8. Pump for whirlpool
9. Stainless steel frame
10. Corner orientation

### More options:

1. Touch control panel
2. Ozonizer- sterlization system
3. Temperature control heater
4. Air massage function
5. Music / radio player
6. Water lines cleaning system
7. Available version- only one



HYGREE  
www.hygree.in



**HJT-123**

MODEL: ALAMERE

Size: 1360X1360X650MM

Description: Acrylic whirlpool bath tub

**Features & options**

1. Water jets- hydraulic massage
2. Chromatherapy-light
3. Hand shower with multi flow
4. Hot & cold mixer
5. Spout - waterfall
6. Drainer
7. Over flow
8. Pump for whirlpool
9. Stainless steel frame
10. Tempered glass front panel
11. Corner orientation



**More options:**

1. Touch control panel
2. Ozonizer- sterilization system
3. Temperature control heater
4. Air massage function
5. Music / radio player
6. Water lines cleaning system
7. Available version only one



**HJT-108**

MODEL: KAIETEUR

Size: 1560X1560X720

Description: Acrylic whirlpool bath tub

**Features & options**

1. Water jets- hydraulic massage
2. Chromatherapy-light
3. Hand shower with multi flow
4. Hot & cold mixer
5. Spout - waterfall
6. Drainer
7. Over flow
8. Pump for whirlpool
9. Stainless steel frame
10. Tempered glass front panel
11. Corner orientation

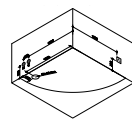
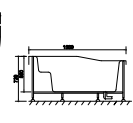
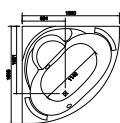

**More options:**

1. Touch control panel
2. Ozonizer- sterilization system
3. Temperature control heater
4. Air massage function
5. Music / radio player
6. Water lines cleaning system
7. Available version only one





HYGREE  
www.hygree.in



### HJT-109

MODEL: GULLFOSS

Size: 1600X1600X800MM

Description: Acrylic whirlpool bath tub

#### Features & options

1. Water jets- hydraulic massage
2. Chromatherapy-light
3. Hand shower with multi flow
4. Hot & cold mixer
5. Spout- deluxe
6. Drainer
7. Over flow
8. Pump for whirlpool
9. Stainless steel frame
10. Tempered glass front panel
11. Corner orientation

#### More options:

1. Touch control panel
2. Ozonizer- sterilization system
3. Temperature control heater
4. Air massage function
5. Music / radio player
6. Water lines cleaning system
7. Available version only one

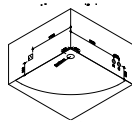
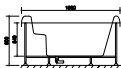
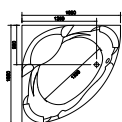

### HJT-112

MODEL: BRIDALVEIL

Size: 1500X1500X630MM

Description: Acrylic whirlpool bath tub

#### Features & options

1. Water jets- hydraulic massage
2. Chromatherapy-light
3. Hand shower with multi flow
4. Hot & cold mixer
5. Spout - waterfal
6. Drainer
7. Over flow
8. Pump for whirlpool
9. Stainless steel frame
10. Tempered glass front panel
11. Corner orientation

#### More options:

1. Touch control panel
2. Ozonizer- sterilization system
3. Temperature control heater
4. Air massage function
5. Music / radio player
6. Water lines cleaning system
7. Available version only one

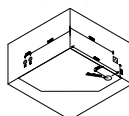
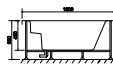
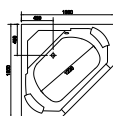



**HYGREE**  
www.hygree.in

**HYGREE- *We Care***  
**SPECIAL ELDER CARE BATH**



**VALUE ADDITION FOR THE LIMITED EDITION**

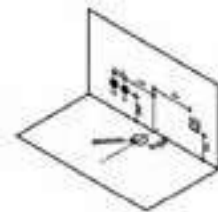
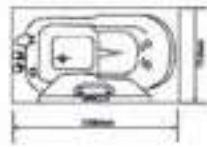
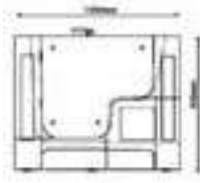

**HJTE-127**

MODEL: PALOUSE

Size: 1300X750X950MM

**Description:** Acrylic whirlpool bath tub

**Features & options**

1. Water jets- hydraulic massage
2. Chromotherapy-light
3. Hand shower with multi flow
4. Hot & cold mixer
5. Spout- deluxe
6. Drainer
7. Over flow
8. Pump for whirlpool
9. Stainless steel frame
10. Three sides panel



**More options:**

1. Touch control panel
2. Ozonizer- sterilization system
3. Temperature control heater
4. Music / radio player
5. Water lines cleaning system
6. Available version only one

**• NEW LAUNCH**



**HYGREE**  
www.hygree.in

**HYGREE- *We Care***  
**SPECIAL ELDER CARE BATH**

**SENIORS STEP INTO THE  
LAP OF LUXURY AND TRANQUILITY**

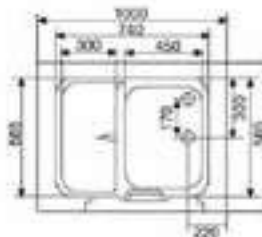
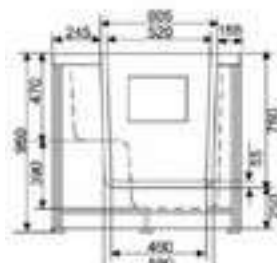

**HJTE-126**

MODEL: CASCADAS

Size: 1000X780X950MM

**Description:** Acrylic whirlpool bath tub

**Features & options**

1. Water jets- hydraulic massage
2. Chromatherapy-light
3. Hand shower with multi flow
4. Hot & cold mixer
5. Spout- deluxe
6. Drainer
7. Over flow
8. Pump for whirlpool
9. Stainless steel frame
10. Three sides panel



**More options:**

1. Touch control panel
2. Ozonizer- sterilization system
3. Temperature control heater
4. Music / radio player
5. Water lines cleaning system
6. Available version only one

**• NEW LAUNCH**



HYGREE  
www.hygree.in



# *Elliptical Ensembles*

Whip your bathroom into shape! Striking and unusual, creating an instant focal point in the bathroom.



HYGREE



**HYGREE**  
www.hygree.in



*“Sometimes the most important thing in a whole day is the rest we take between two deep breaths.” - Ety Hillesum*

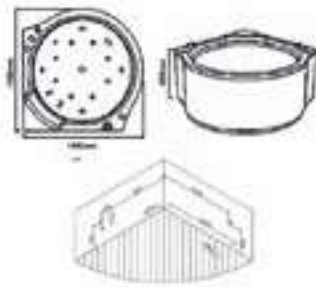

**HJT-128**

MODEL: YOSEMITE

Size: 1400X1400X710MM

**Description:** Acrylic whirlpool bath tub

**Features & options**

1. Water jets- hydraulic massage
2. Waterfal- cascade side panel
3. Chromatherapy-light
4. Electronic hot & cold mixer
5. Spout- special
6. Drainer
7. Over flow
8. Pump for whirlpool
9. Touch control panel
10. Automatic water lines cleaning system
11. Stainless steel frame
12. Corner orientation- round

**More options-**

1. Ozonizer- sterlization system
2. Temperature control heater
3. Music / radio player
4. Available version- only one

• **NEW LAUNCH**



**HYGREE**  
www.hygree.in

*Let your Senses soar, deep in the lap of ripples. Soothing beyond your comprehension.*

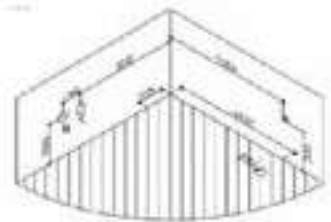
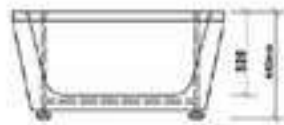
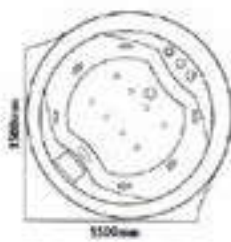

### **HJT-124**

MODEL: PLITVICE

Size: 1500X1500X620MM

**Description:** Acrylic whirlpool bath tub

#### **Features & options**

1. Water jets- hydraulic massage
2. Chromatherapy-light
3. Hand shower with multi flow
4. Hot & cold mixer
5. Spout- waterfall
6. Drainer
7. Over flow
8. Pump for whirlpool
9. Stainless steel frame
10. Corner orientation- round

#### **More options:**

1. Touch control panel
2. Ozonizer- sterilization system
3. Temperature control heater
4. Air massage function
5. Music / radio player
6. Water lines cleaning system
7. Available version- only one

• **NEW LAUNCH**



HYGREE  
www.hygree.in

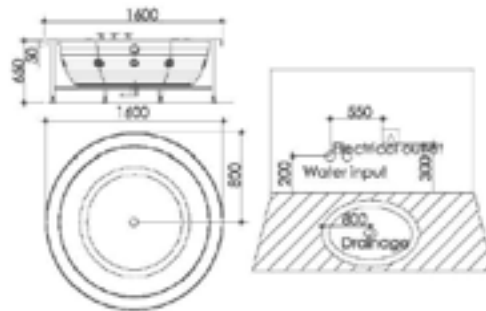

### HJT-131

MODEL: MULTNOMAH

Size: 1600X1600X650MM

**Description:** Acrylic whirlpool bath tub

#### Features & options

1. Water jets- hydraulic massage
2. Chromatherapy-light
3. Hand shower with multi flow
4. Hot & cold mixer
5. Spout- deluxe
6. Drainer
7. Over flow
8. Pump for whirlpool
9. Stainless steel frame
10. Free standing round

#### More options:

1. Touch control panel
2. Ozonizer- sterilization system
3. Air massage function
4. Music / radio player
5. Water lines cleaning system
6. Available version- only one



HYGREE  
www.hygree.in

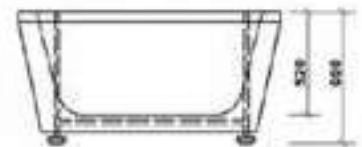
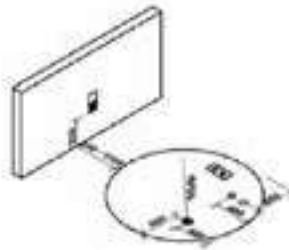
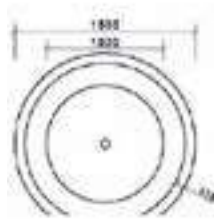

### HJT-125

MODEL: GAPING GILL

Size: 1500X1500X690MM

**Description:** Acrylic whirlpool bath tub

#### Features & options

1. Water jets- hydraulic massage
2. Chromatherapy-light
3. Hand shower with multi flow
4. Hot & cold mixer
5. Spout- deluxe
6. Drainer
7. Over flow
8. Pump for whirlpool
9. Stainless steel frame
10. Free standing round

#### More options:

1. Touch control panel
2. Ozonizer- sterilization system
3. Air massage function
4. Music / radio player
5. Water lines cleaning system
6. Available version- only one

• NEW LAUNCH





**HYGREE**  
www.hygree.in

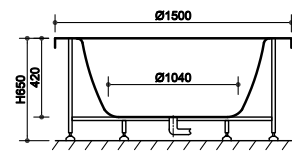
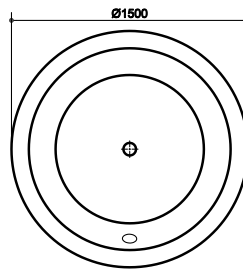
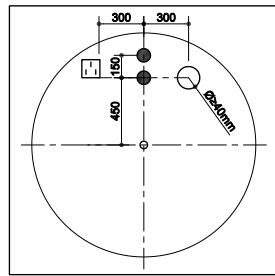

**HJT-132-Size:** 1500X1500X690MM

**HJT-132S-Size:** 1800X1800X650MM

**MODEL:** RORAIMA

**Description:** Acrylic whirlpool bath tub

**Features & options**

1. Water jets- hydraulic massage
2. Chromatherapy-light
3. Hand shower with multi flow
4. Hot & cold mixer
5. Spout- deluxe
6. Drainer
7. Over flow
8. Pump for whirlpool
9. Stainless steel frame
10. Free standing round

**More options:**

1. Touch control panel
2. Ozonizer- sterlization system
3. Air massage function
4. Music / radio player
5. Water lines cleaning system
6. Available version- only one

• **NEW LAUNCH**



# *Freestanding Bathtubs*

*G*ive your bathroom the ultimate  
in relaxation with trying a  
deep soaking tub design

HFST-205-Size: 1700X800X600MM  
MODEL: KEGON



HYGREE  
www.hygree.in



**HFST-201-Size:** 1800X800X600MM **MODEL:** SVARTIFOSS



**HFST-202-Size:** 1750X950X600MM **MODEL:** TRUMMELBACH



**HFST-204-Size:** 1700X800X600MM  
**HFST-204S-Size:** 1600X800X600MM  
**MODEL:** TOKETEE



**HFST-205-Size:** 1700X800X600MM  
**HFST-205S-Size:** 1600X800X600MM  
**HFST-205SS-Size:** 1500X750X580MM  
**MODEL:** SHOSHONE



**HFST-208-Size:** 1700X700X600MM  
**MODEL:** ERAWAN





HYGREE  
[www.hygree.in](http://www.hygree.in)

# *Shower Space*

From floor to ceiling, wall to wall, Hygree offers you all the products needed to create a dream shower for every style and lifestyle.



HYGREE  
www.hygree.in



### STEAM SHOWER CABIN - GLASS CONCEPT

Model Number: HSR 055  
Model: ROTORUA  
Material: Glass  
Size: 1080X1080X2230MM  
Seating: 1 Person

### DESCRIPTION

Acrylic tray and body with tempered glass

### Features & options

- |   |                                   |
|---|-----------------------------------|
| 1. Steam bath with temperature & timer settings | 6. Top light                      |
| 2. Hand shower with multi flow & slide bar      | 7. Speaker                        |
| 3. Body massage- water jets/ spray              | 8. Top shower                     |
| 4. Hot & cold mixer                             | 9. Ozonizer- sterilization system |
| 5. Exhaust fan                                  | 10. Touch control panel           |
|   | 11. Speaker phone                 |
|   | 12. Shampoo rack                  |
|   | 13. Music / radio player          |

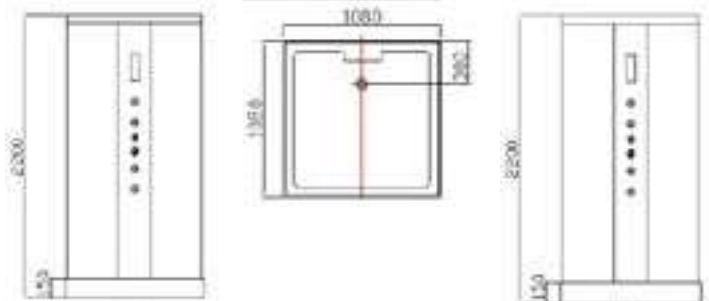

### More options-

1. Foot massager
2. Available version- left or right



### STEAM SHOWER CABIN - GLASS CONCEPT

Model Number: HSR 056  
Model: PAMUKKALE  
Material: Glass  
Size: 1200X900X2200MM  
Seating: 1 Person

#### DESCRIPTION

Acrylic tray and body with tempered glass

#### Features & options

- |   |                                   |
|---|-----------------------------------|
| 1. Steam bath with temperature & timer settings | 6. Top light                      |
| 2. Hand shower with multi flow & slide bar      | 7. Speaker                        |
| 3. Body massage- water jets/ spray              | 8. Top shower                     |
| 4. Hot & cold mixer                             | 9. Ozonizer- sterilization system |
| 5. Exhaust fan                                  | 10. Touch control panel           |
|   | 11. Speaker phone                 |
|   | 12. Shampoo rack                  |
|   | 13. Music / radio player          |

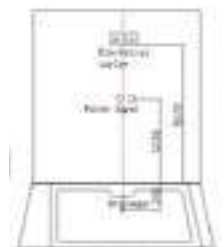
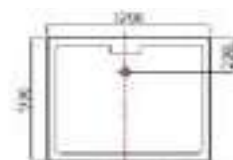

#### More options-

1. Foot massager
2. Available version- left or right



HYGREE  
www.hygree.in



### STEAM SHOWER CABIN - ACRYLIC CONCEPT

Model Number: HSR 059  
Model: DALLOL  
Material: Acrylic  
Size: 1500X1000X2200MM  
Seating: 2 Person

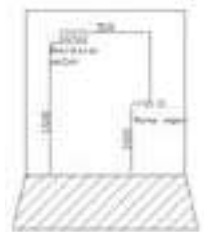
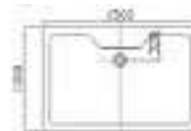

### DESCRIPTION

Acrylic tray and body with tempered glass

### Features & options

- |   |                                    |
|---|------------------------------------|
| 1. Steam bath with temperature & timer settings | 6. Body massage- water jets/ spray |
| 2. Touch control panel                          | 7. Exhaust fan                     |
| 3. Hot & cold mixer                             | 8. Top light                       |
| 4. Top shower                                   | 9. Speaker                         |
| 5. Hand shower with multi flow & slide bar      | 10. Ozonizer- sterilization system |
|   | 11. Speaker phone                  |
|   | 12. Shampoo rack                   |
|   | 13. Music / radio player           |

### More options-

1. Foot massager
2. Available version- left or right





### STEAM SHOWER CABIN - ACRYLIC CONCEPT

Model Number: HSR-060  
Model: EL TATIO  
Material: Acrylic  
Size: 1060X1060X2150MM  
Seating: 1 Person

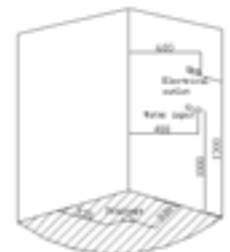
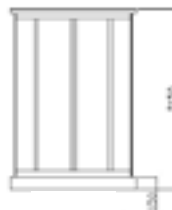

### DESCRIPTION

Acrylic tray and body with tempered glass

### Features & options

- |   |                                    |
|---|------------------------------------|
| 1. Steam bath with temperature & timer settings | 6. Body massage- water jets/ spray |
| 2. Touch control panel                          | 7. Exhaust fan                     |
| 3. Hot & cold mixer                             | 8. Top light                       |
| 4. Top shower                                   | 9. Speaker                         |
| 5. Hand shower with multi flow & slide bar      | 10. Ozonizer- sterilization system |
|   | 11. Speaker phone                  |
|   | 12. Shampoo rack                   |
|   | 13. Music / radio player           |

### More options-

1. Foot massager
2. Available version- left or right



HYGREE  
www.hygree.in



### STEAM SHOWER CABIN - ACRYLIC CONCEPT

Model Number: HSR-065  
Model: BEPPU  
Material: Acrylic  
Size: 950X950X2200MM  
Seating: 1 Person

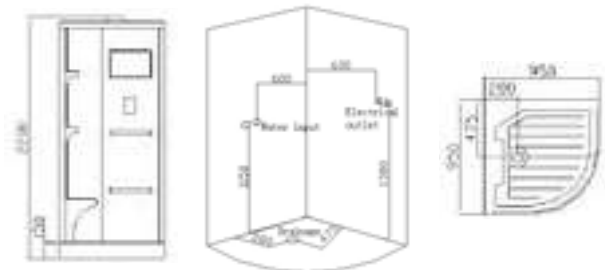

### DESCRIPTION

Acrylic tray and body with tempered glass

### Features & options

- |   |                                    |
|---|------------------------------------|
| 1. Steam bath with temperature & timer settings | 7. Exhaust fan                     |
| 2. Touch control panel                          | 8. Top light                       |
| 3. Hot & cold mixer                             | 9. Speaker                         |
| 4. Top shower                                   | 10. Ozonizer- sterilization system |
| 5. Hand shower with multi flow & slide bar      | 11. Speaker phone                  |
| 6. Body massage- water jets/ spray              | 12. Shampoo rack                   |
|   | 13. Music / radio player           |

### More options-

1. Foot massager
2. Available version- left or right



### STEAM SHOWER CABIN - ACRYLIC CONCEPT

Model Number: HSR - 064  
Model: RINCON  
Material: Acrylic  
Size: 1180x950x2200MM  
Seating: 1 Person

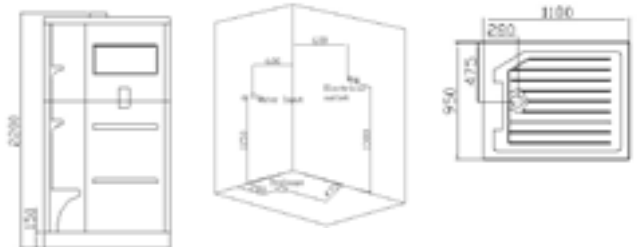

### DESCRIPTION

Acrylic tray and body with tempered glass

### Features & options

- |   |                                    |
|---|------------------------------------|
| 1. Steam bath with temperature & timer settings | 6. Body massage- water jets/ spray |
| 2. Touch control panel                          | 7. Exhaust fan                     |
| 3. Hot & cold mixer                             | 8. Top light                       |
| 4. Top shower                                   | 9. Speaker                         |
| 5. Hand shower with multi flow & slide bar      | 10. Ozonizer- sterilization system |
|   | 11. Speaker phone                  |
|   | 12. Shampoo rack                   |
|   | 13. Music / radio player           |

### More options-

1. Foot massager
2. Available version- left or right



HYGREE  
www.hygree.in



## STEAM | SAUNA SHOWER CABIN

Model Number: HSR-06I  
Model: FOSSO  
Material: Acrylic and Wood  
Size: 1800X1200X2280MM

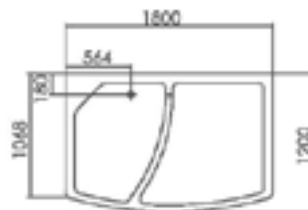

### DESCRIPTION

Acrylic tray and body with tempered glass

#### Features & options

- |   |                                    |
|---|------------------------------------|
| 1. Sauna stove 2.8 ~ 3Kw                        | 8. Body massage- water jets/ spray |
| 2. Steam bath with temperature & timer settings | 9. Exhaust fan                     |
| 3. Touch control panel                          | 10. Top light                      |
| 4. Doors between steam and sauna room           | 11. Speaker                        |
| 5. Hot & cold mixer                             | 12. Ozonizer- sterilization system |
| 6. Top shower                                   | 13. Speaker phone                  |
| 7. Hand shower with multi flow & slide bar      | 14. Shampoo rack                   |
|   | 15. Music / radio player           |
|   | 16. Seat for relaxation            |
|   | 17. Sauna timer and accessories    |

#### More options-

1. Foot massager
2. Available version- only one

#### Advantage-

Easy installation and assembling of sauna cum steam room



# *Enhance your showering experience*

---

This space of fantasy has the ability to shape both the mood and the way we experience the showering bliss.



HYGREE  
www.hygree.in



### STEAM CABIN WITH MASSAGE TUB CONCEPT

Model Number: HST 002  
Model: BIANCO  
Material: Acrylic  
Size: 1360X1360X2280MM  
Seating: 1 Person

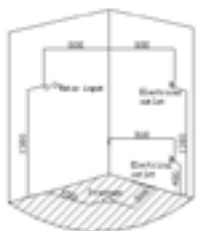

### DESCRIPTION

Acrylic whirlpool bath tub and body

### Features & options Cabin

1. Steam bath with temperature & timer settings
2. Touch control panel
3. Hot & cold mixer
4. Top shower
5. Hand shower with multi flow & slide bar
6. Body massage- water jets/ spray
7. Exhaust fan
8. Top light
9. Speaker
10. Speaker phone
11. Shampoo rack
12. Music / radio player
13. Corner orientation

### Bath tub

1. Water jets- hydraulic massage
2. Chromatherapy-light
3. Hand shower with multi flow
4. Hot & cold mixer
5. Spout- waterfal
6. Drainer
7. Over flow
8. Pump for whirlpool
9. Stainless steel frame
10. Tempered glass front panel
11. Corner orientation

### More options-

1. Ozonizer- sterilization system
2. Temperature control heater
3. Air massage function
4. Music / radio player
5. Foot massager
6. Water lines cleaning system
7. Available version- only one



### STEAM SHOWER CABIN WITH TUB CONCEPT

Model Number: HST-005  
Model GRUTAS  
Material: Acrylic  
Size: 900X900X2220MM  
Seating: 1 Person

### DESCRIPTION

Acrylic tub and body with tempered glass

### Features & options

1. Steam Bath With Temperature & Timer Settings
2. Touch Control Panel
3. Hot & Cold Mixer
4. Top Shower
5. Hand Shower With Multi Flow & Slide Bar
6. Body Massage- Water Jets/ Spray
7. Exhaust Fan
8. Top Light
9. Speaker
10. Ozonizer- Sterlization System
11. Speaker Phone
12. Shampoo Rack
13. Music / Radio Player
14. Soaking Bath Tub
15. Corner Orientation

### More options-

1. Foot massager
2. Available version- only one

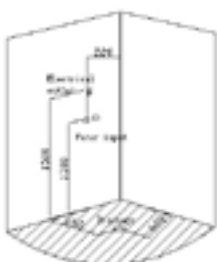



HYGREE  
www.hygree.in



### STEAM CABIN WITH MASSAGE TUB

Model Number: HST-006  
Model: TOLANTONGO  
Material: Acrylic  
Size: 1510X1510X2250MM  
Seating: 2 Person

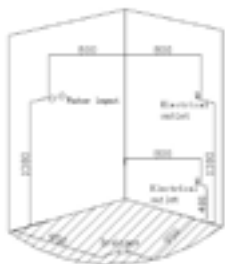

### DESCRIPTION

Acrylic whirlpool bath tub and body

#### Features & options Cabin

1. Steam bath with temperature & timer settings
2. Touch control panel
3. Hot & cold mixer
4. Top shower
5. Hand shower with multi flow & slide bar
6. Body massage- water jets/ spray
7. Exhaust fan
8. Top light
9. Speaker
10. Speaker phone
11. Shampoo rack
12. Music / radio player
13. Corner orientation

#### Bath tub

1. Water jets- hydraulic massage
2. Chromatherapy-light
3. Hand shower with multi flow
4. Hot & cold mixer
5. Spout- waterfall
6. Drainer
7. Over flow
8. Pump for whirlpool
9. Stainless steel frame
10. Tempered glass front panel
11. Corner orientation

#### More options-

1. Ozonizer-sterilization system
2. Temperature control heater
3. Air massage function
4. Music / radio player
5. Foot massager
6. Water lines cleaning system
7. Available version- only one





### STEAM CABIN WITH MASSAGE TUB

Model Number: HST-009  
Model: PENINSULA  
Material: Acrylic  
Size: 1250X1250X2250MM  
Seating: 1 Person

### DESCRIPTION

Acrylic whirlpool bath tub and body

#### Features & options Cabin

1. Steam bath with temperature & timer settings
2. Touch control panel
3. Hot & cold mixer
4. Top shower
5. Hand shower with multi flow & slide bar
6. Body massage- water jets/ spray
7. Exhaust fan
8. Top light
9. Speaker
10. Speaker phone
11. Shampoo rack
12. Music / radio player
13. Corner orientation

#### Bath tub

1. Water jets- hydraulic massage
2. Chromatherapy-light
3. Hand shower with multi flow
4. Hot & cold mixer
5. Spout- waterfall
6. Drainer
7. Over flow
8. Pump for whirlpool
9. Stainless steel frame
10. Tempered glass front panel
11. Corner orientation

#### More options-

1. Ozonizer-sterilization system
2. Temperature control heater
3. Air massage function
4. Music / radio player
5. Foot massager
6. Water lines cleaning system
7. Available version- only one

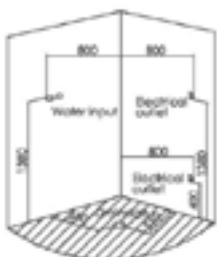



## Disclaimer

The information contained within this brochure and the functions offered are intended to provide information about products available for purchase from Hygree. All reasonable efforts have been made to ensure the accuracy of the information. However, Hygree cannot be held responsible for any errors whatsoever. Hygree does not warrant the accuracy and Hygree reserves the right to make changes to the product, its function and the brochures at any time without prior notice.

Hygree accepts no responsibility or liability for any losses or damages of any kind arising out of the use of this brochure or any of its related forms.

All images used are for illustrative purposes only. The dimensions and the scale of each product depicted here are for illustrative purpose and the actual size and scale may differ from the image shown here. All information, Content, Images included in this brochure are provide by Hygree and are copyright of Hygree. No information content images in any form expressed or implied can be used by anybody, individual or corporate unless otherwise written approval from Hygree is obtained.

## Notes

---

---

---

---

---

---

---

---

---

---

---





HYGREE

**HYGREE WATERFAL**

Complete Bath & Restroom Solutions

An ISO 9001 : 2015 CERTIFIED COMPANY

12 | Playground Street | Kilpauk Garden Colony | Chennai-600 010 | India

☎ +91 90948 88829 | ☎ 044 2644 5387 | @ sales@hygree.in | 🌐 www.hygree.in